

# RGB Buck-Boost 3-Channel Color Sequencing LED Driver

## ISL97900

The ISL97900 is a highly efficient 3-channel, 1.5A sequential LED driver powered from a single-cell Li-ion battery, or regulated input voltage up to 5.5V. This LED driver incorporates an independent current controlled driving mechanism for each of the LED's, which allows accurate current control of the LED brightness.

The ISL97900 utilizes a buck-boost converter to ensure that optimum output voltage is maintained for a wide range of LED forward voltages. The integrated buck-boost converter operates well over 90% efficiency across a wide range of operating conditions. The power conversion core implements a proprietary algorithm that allows seamless transitions and glitch-free operation between the buck and the boost modes as the battery voltage drops during operation.

The ISL97900 architecture includes a 10-bit DAC, which controls the LED currents. Each of the LED currents can be programmed through serial interface.

The ISL97900 also includes the Dynamic Headroom Management function to provide seamless adjustment for the LEDs' voltages, which reduces power consumption.

## Features

- Buck-boost based LED driver
- RGB color sequencing
- Up to 1.5A output current
- I<sup>2</sup>C Interface
- 150mV feedback voltage reference for current regulation to maximize efficiency
- 2.5MHz switching frequency
- Programmable output voltage and output current for each LED
- Dynamic headroom management
- Internal current setting registers
- Ambient temperature range: 0°C to +70°C
- Pb-free (RoHS compliant)

## Applications

- LED-based pico projector in mobile phones
- Stand-alone pico projectors
- Tri-stimulus display drivers
- Other handheld display drivers

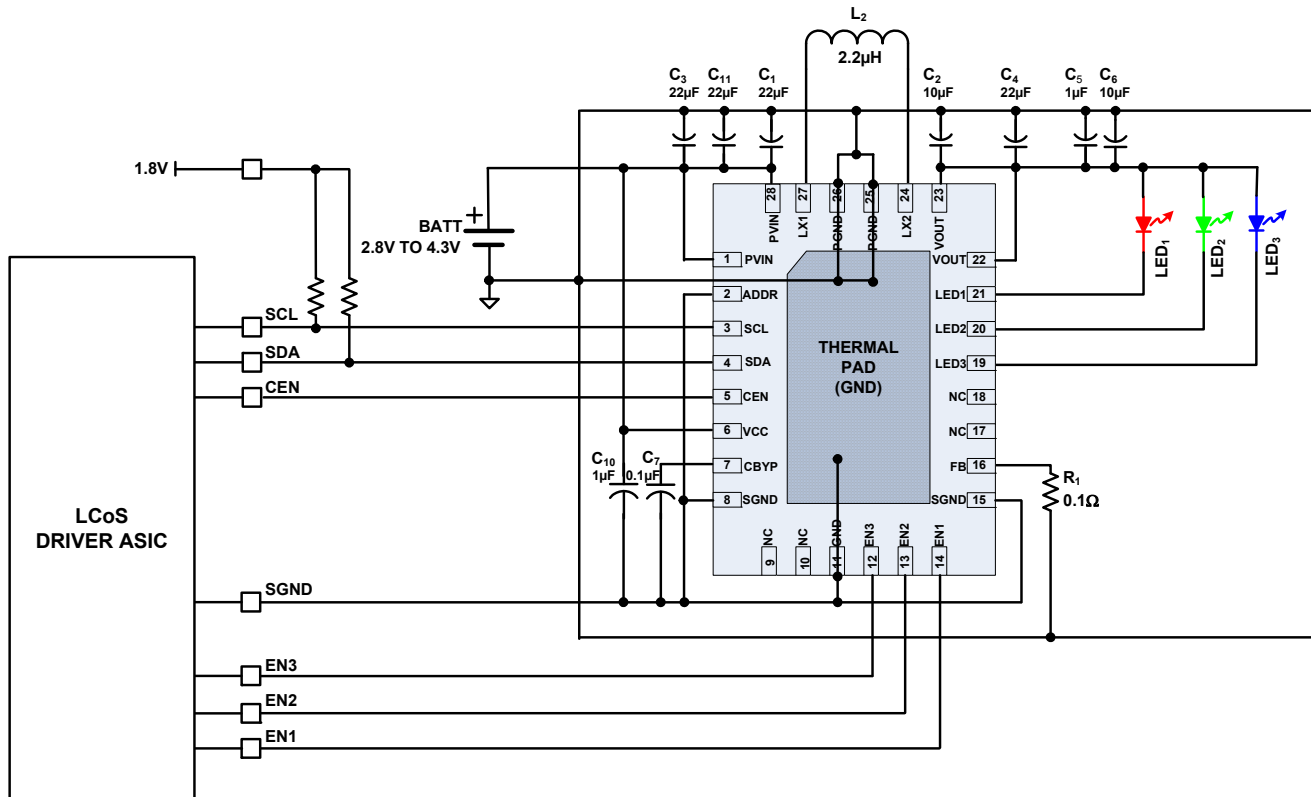

FIGURE 1. TYPICAL APPLICATION

# ISL97900

---

For additional products, see [www.intersil.com/product\\_tree](http://www.intersil.com/product_tree)

---

Intersil products are manufactured, assembled and tested utilizing ISO9001 quality systems as noted in the quality certifications found at [www.intersil.com/design/quality](http://www.intersil.com/design/quality)

---

*Intersil products are sold by description only. Intersil Corporation reserves the right to make changes in circuit design, software and/or specifications at any time without notice. Accordingly, the reader is cautioned to verify that data sheets are current before placing orders. Information furnished by Intersil is believed to be accurate and reliable. However, no responsibility is assumed by Intersil or its subsidiaries for its use; nor for any infringements of patents or other rights of third parties which may result from its use. No license is granted by implication or otherwise under any patent or patent rights of Intersil or its subsidiaries.*

---

For information regarding Intersil Corporation and its products, see [www.intersil.com](http://www.intersil.com)