

Panasonic

Panasonic

HC2E-H-AC48V-F

Hissə nömrəsi:

HC2E-H-AC48V-F

İstehsalçı / Marka:

Panasonic

Məhsulun təsviri

HC RELAY 2 FORM C 48VAC

Datasheets:

[PDF HC2E-H-AC48V-F.pdf](#)

RoHS Status

 Qurğundur pulsuz / RoHS uyğun

Dən gəmi

Honq Konq

Göndərmə yolu

DHL/Fedex/TNT/UPS/EMS

[KOTIROVKA SORĞUSU](#)

Image nümayəndəlik ola bilər. Məhsul detalları üçün spesifikasiyalara baxın.







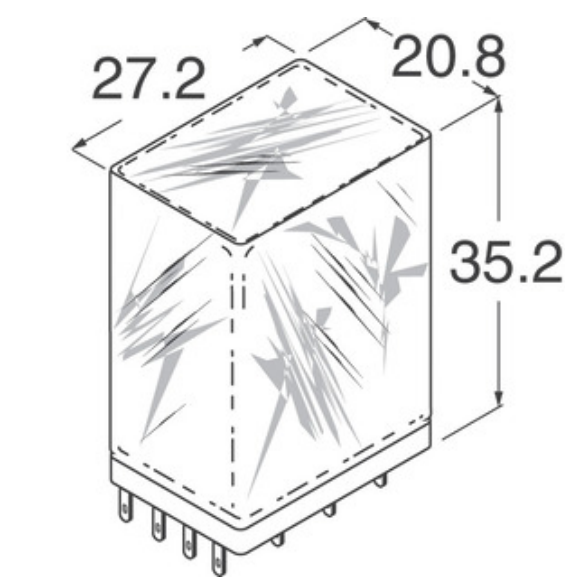



HC2E-H-AC48V-F xüsusiyyətləri

| | |
|--|--|
| HISSƏ NÖMRƏSİ | HC2E-H-AC48V-F |
| İSTEHSALÇI | Panasonic |
| TƏSVİR | HC RELAY 2 FORM C 48VAC |
| PULSUZ VƏZİYYƏT / ROHS STATUSUNA ETMƏK | Qurğundur pulsuz / RoHS uyğun |
| MƏLUMAT BAZASI | PDF HC2E-H-AC48V-F.pdf |
| SERIES | * |
| NƏMLİK HƏSSASLIĞI SƏVIYYƏSİ (MSL) | 1 (Unlimited) |
| PULSUZ VƏZİYYƏT / ROHS STATUSUNA ETMƏK | Lead free / RoHS Compliant |
| ƏTRAFLI TƏSVİRİ | Relay Coil |

İlgili Etiketlər

| | | |
|---|--|---|
| Panasonic HC2E-H-AC48V-F | HC2E-H-AC48V-F Distribyutoru | HC2E-H-AC48V-F Təchizatçı |
| HC2E-H-AC48V-F Qiyməti | HC2E-H-AC48V-F Şəkillər | HC2E-H-AC48V-F Şəkli |
| HC2E-H-AC48V-F PDF məlumat cədvəli | HC2E-H-AC48V-F verilənlər bazasını yükləyin | HC2E-H-AC48V-F Məlumat Hesabatı |
| HC2E-H-AC48V-F Fond | HC2E-H-AC48V-F satın alın | Panasonic HC2E-H-AC48V-F alın |
| Panasonic HC2E-H-AC48V-F | Panasonic Təchizatçı | Panasonic Distribyutoru |
| Panasonic HC2E-H-AC48V-F | Panasonic - Consumer Division HC2E-H-AC48V-F | Panasonic - Consumer Electronics Corp. HC2E-H-AC48V-F |
| Panasonic Battery Group HC2E-H-AC48V-F | Panasonic Electric Works - ACSD HC2E-H-AC48V-F | Panasonic Electronic Components - Semiconductor Pr HC2E-H-AC48V-F |
| Panasonic - ATG HC2E-H-AC48V-F | Panasonic - BSG HC2E-H-AC48V-F | Panasonic - DTG HC2E-H-AC48V-F |
| Panasonic Electric Works HC2E-H-AC48V-F | Panasonic Electronic Components HC2E-H-AC48V-F | Panasonic Industrial Automation Sales HC2E-H-AC48V-F |
| Panasonic Semiconductor HC2E-H-AC48V-F | | |

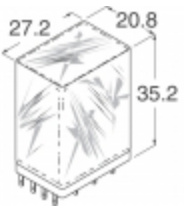
Əlaqədar məhsullar

| | |
|---|--|
|  <p>HC2E-H-AC6V-F İstehsalçılar: Panasonic Təsvir: HC RELAY 2 FORM C 6VAC Səhmdarlar: Out stock</p> <p>RFQ</p> |  <p>HC2E-H-DC110V-F İstehsalçılar: Panasonic Təsvir: HC RELAY Səhmdarlar: Out stock</p> <p>RFQ</p> |
|  <p>HC2E-H-AC6V İstehsalçılar: Panasonic Təsvir: RELAY GENERAL PURPOSE DPDT 3A 6V Səhmdarlar: Out stock</p> <p>RFQ</p> |  <p>HC2E-H-AC24V İstehsalçılar: Panasonic Təsvir: RELAY GEN PURPOSE DPDT 3A 24V Səhmdarlar: Out stock</p> <p>RFQ</p> |
|  <p>HC2E-H-AC200V-F İstehsalçılar: Panasonic Təsvir: RELAY GEN PURP DPDT 200VAC Səhmdarlar: Out stock</p> <p>RFQ</p> |  <p>HC2E-H-AC24V-F İstehsalçılar: Panasonic Təsvir: HC RELAY 2 FORM C 24VAC Səhmdarlar: Out stock</p> <p>RFQ</p> |
|  <p>HC2E-H-DC100V-F İstehsalçılar: Panasonic Təsvir: RELAY GEN PURP DPDT 100VDC Səhmdarlar: Out stock</p> <p>RFQ</p> |  <p>HC2E-H-DC12V İstehsalçılar: Panasonic Təsvir: RELAY GEN PURPOSE DPDT 3A 12V Səhmdarlar: Out stock</p> <p>RFQ</p> |
|  <p>HC2E-H-DC110V İstehsalçılar: Panasonic Təsvir: RELAY GEN PURPOSE DPDT 3A 110V Səhmdarlar: Out stock</p> <p>RFQ</p> |  <p>HC2E-H-AC240V-F İstehsalçılar: Panasonic Təsvir: HC RELAY 2 FORM C 240VAC Səhmdarlar: Out stock</p> <p>RFQ</p> |
|  <p>HC2E-H-AC240V İstehsalçılar: Panasonic Təsvir: RELAY GEN PURPOSE DPDT 3A 240V Səhmdarlar: Out stock</p> <p>RFQ</p> |  <p>HC2E-H-AC48V İstehsalçılar: Panasonic Təsvir: RELAY GEN PURPOSE DPDT 3A 48V Səhmdarlar: Out stock</p> <p>RFQ</p> |

Müəllif hüquqları © 2020 Elektron komponentlərin etibarlı distribyutoru - Ocean-Components.com

E-poçt: Info@Ocean-Components.com

Ünvan: Room 2102, Connaught Commercial Building, 185 Wan Chai Rd, Wan Chai, Hong Kong

